

REDUTA 150

EN Mounting instructions

CZ Montážní návod

H Szerelési utasítás

RU Инструкция по монтажу

D/A Montageanleitung

PL Instrukcja montażu

RO Instrucțiuni de montaj

ES Manual de instrucciones

FR Notice de montage

NL Montage instructie

LT Montavimo instrukcija

SK Montážny návod

1.

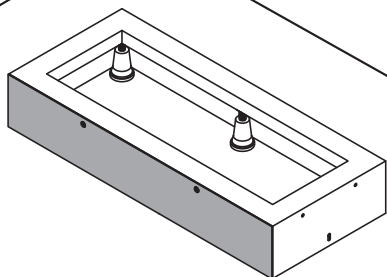

2.

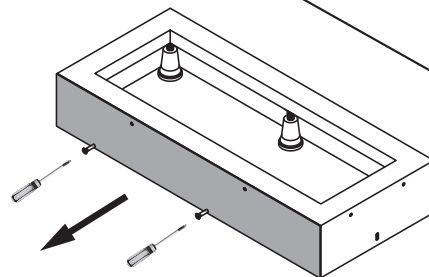

3.

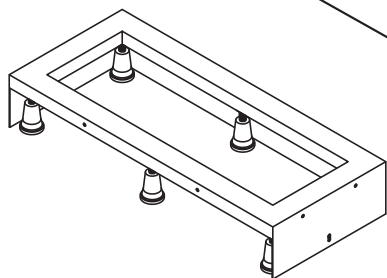

4.

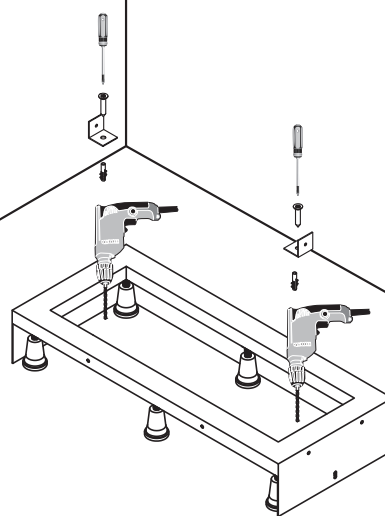

5.

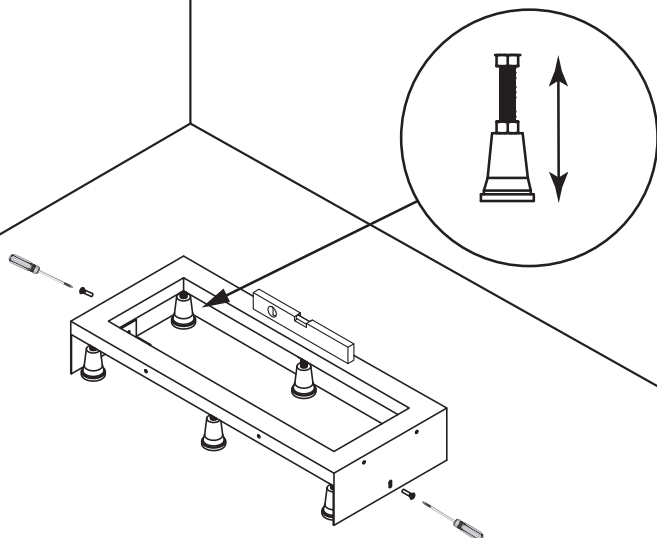

6.

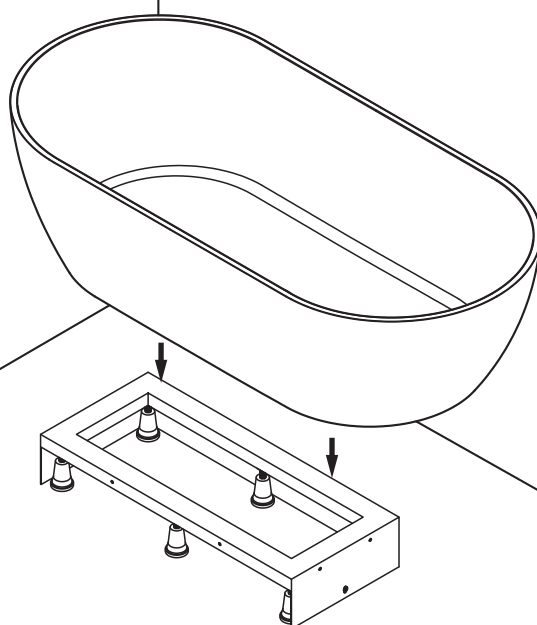

7.

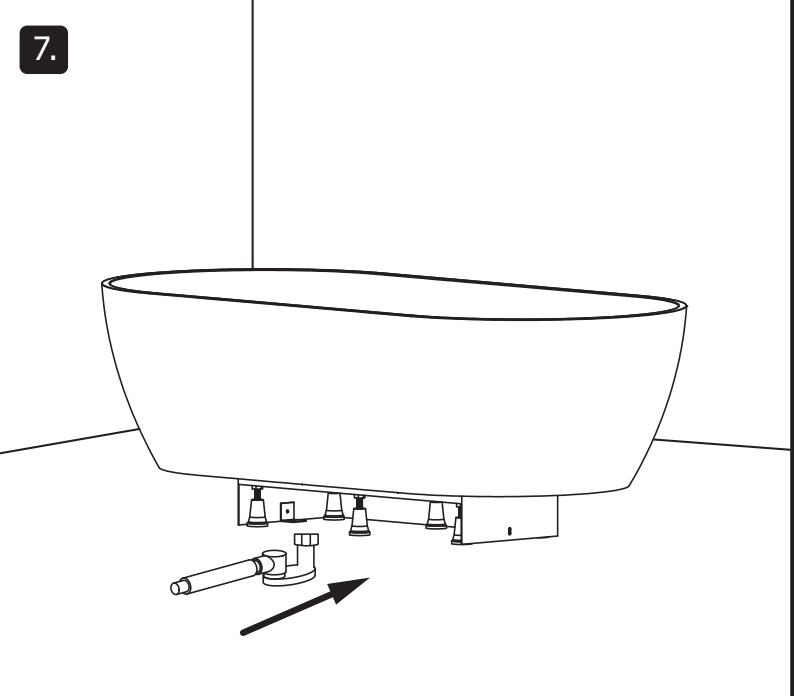

8.

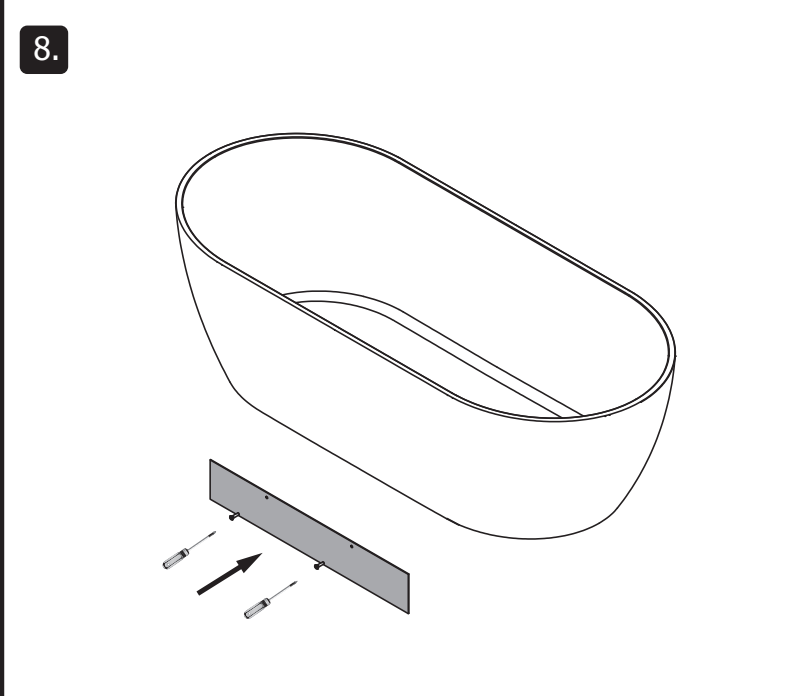

9.

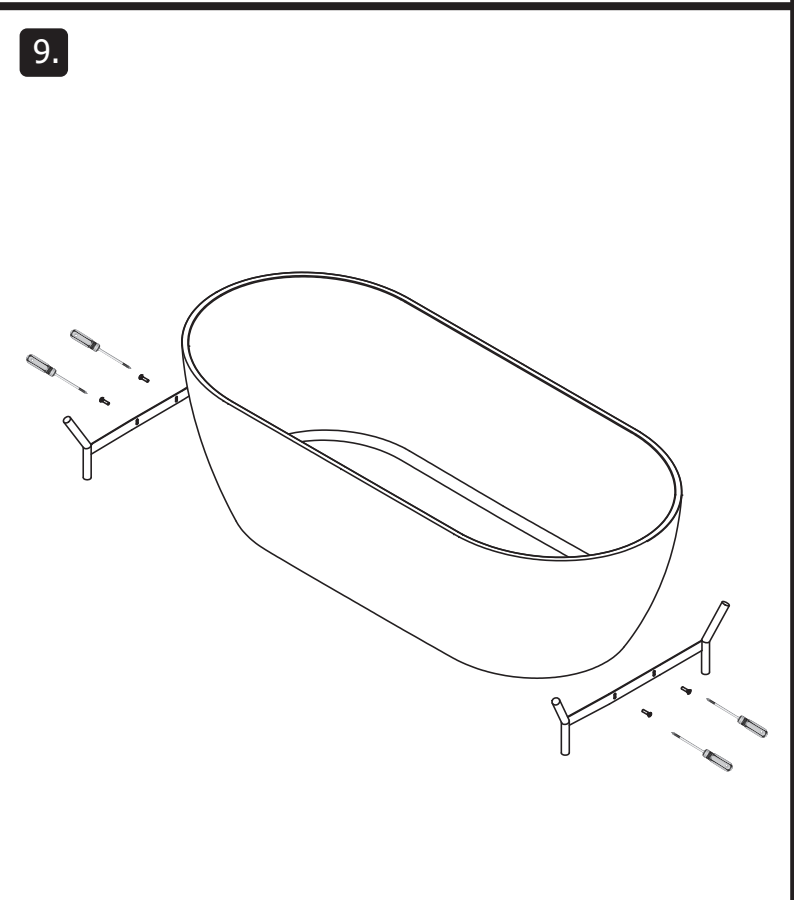

10.

